

## Intelligent LED Driver

- Adopt SAMSUNG/COVESTRO V0 flame resistant polycarbonate protective housings with small size and light weight.
- The clamshell design and screwless type for strain-relief, tensile strength of wires complies with the 0.5-1.5mm<sup>2</sup>wire diameter 60N tensile test, and complies with the tensile test standard GB7000.1-2015/IEC60598-1: 2014.
- Soft-on and fade-in dimming function enhances your visual comfort.
- T-PWM<sup>™</sup> dimming technology allows continuous and flicker-free images under high-speed shooting.
- Dimming from 0-100%, down to 0.01%.
- 0-100% flicker-free dimming with high frequency exemption level.
- Innovative thermal management technology protects the power life intelligently.
- Multi-current & wide voltage, suitable for different power LEDs.
- Class 2 LED driver, full protective plastic housing.
- Comply with Safety Extra Low Voltage standard.
- Overvoltage, overload, short circuit protection and automatic recovery.
- Suitable for indoor light applications of I/II/III type.
- Up to 50000-hour life time.
- 5-year warranty (Rubycon capacitor).

**T-PWM<sup>™</sup>**  
Super depth dimming technology

**Flicker-free**  
IEEE 1789

Dimmable:  
.....  
0.01-100%

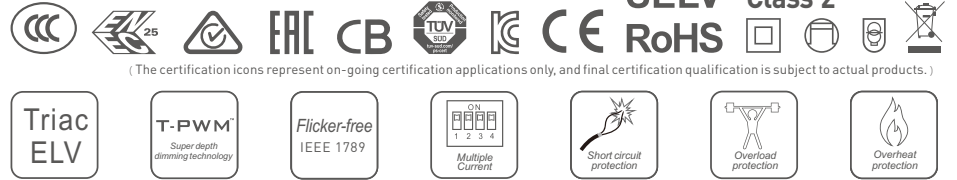

### Technical Specs

Model	SE-9-350-700-G1T	SE-12-350-700-G1T	SE-12-100-400-G1T	SE-15-150-500-G1T	SE-15-350-700-G1T	
OUTPUT	Output Voltage	2-12Vdc	9-24Vdc	9-42Vdc	9-42Vdc	
	Max Output Voltage	≤22V	≤30V	≤50V	≤50V	
	Output Current	350-700mA	350-700mA	100-400mA	150-500mA	
	Load Power Range	0.7W-8.4W	3.15W-12W	0.9W-12W	1.35W-15W	
	Strobe Level	No visible flicker/High frequency exemption level				
	Dimming Range	0-100%, down to 0.01%				
	LF Current Ripple(<120Hz)	<3%				
	Current Accuracy	±5%				
	Ripple & Noise	≤2V				
PWM Frequency	3600Hz					
INPUT	Dimming Interface	Triac leading edge/ELV trailing edge				
	Input Voltage Range	220-240Vac				
	Frequency	50/60Hz				
	Input Current	≤0.08A/230Vac	≤0.09A/230Vac	≤0.1A/230Vac		
	Power Factor	PF>0.9/230Vac (Foll load)				
	THD	THD<15%/230Vac (Foll load)			THD<10%/230Vac (Foll load)	
	Efficiency	>70%@700mA	>76%@500mA	>78%@300mA	>80%@350mA	
	Inrush Current (typ.)	Cold start10A@230Vac [Test twidth=200 us tested under50% Ipeak]				
	Anti Surge	L-N: 1kV				
Leakage Current	<0.5mA/230Vac					
ENVIRONMENT	Working Temperature	ta: -20 ~ 45°C tc: 90°C				
	Working Humidity	20 ~ 95%RH, non-condensing				
	Storage Temperature, Humidity	-40 ~ 80°C, 10 ~ 95%RH				
	Temperature Coefficient	±0.03%/°C (-20°C ~ 45°C)				
	Vibration	10-500HZ, 2G 12min/1cycle, 72 min for X, Y and Z axes respectively.				
PROTECTION	Overload Protection	Shut down the output and recover automatically once it exceeds 1.02-1.35 times of the rated power.				
	Overheat Protection	Intelligently adjust or turn off the current output if the PCB temperature ≥110°C. When the PCB temperature <90°C, automatically recover normal output.				
	Short Circuit Protection	When short circuit occurs, shut down the output and recover automatically.				
SAFETY & EMC	Withstand Voltage	I/P-O/P:3750Vac				
	Insulation Resistance	I/P-O/P:500Vdc/25°C/70%RH≥100MΩ				
	Safety Standards	CCC	China	GB19510.1, GB19510.14		
		TUV	Germany	EN61347-1, EN61347-2-13, EN62493		
		CE	European Union	EN61347-1, EN61347-2-13, EN62384		
		KC	Korea	KC61347-1, KC61347-2-13		
		RCM	Australia	AS61347-1, AS61347-2-13		
		ENEC	Europe	EN61347-1, EN61347-2-13, EN62384		
		CB	CB member states	IEC61347-1, IEC61347-2-13		
		EAC	Russia	IEC61347-1, IEC61347-2-13		
	EMC Emission	CCC	China	GB/T17743, GB17625.1		
		CE	European Union	EN55015, EN61000-3-2, EN61000-3-3, EN61547		
		KC	Korea	KN15, KN61547		
		RCM	Australia	EN55015, EN61000-3-2, EN61000-3-3, EN61547		
		EAC	Russia	IEC62493, IEC61547, EH55015		
EMC Immunity	EN61000-4-2,3,4,5,6,8,11, EN61547					
Strobe Test Standard	IEEE 1789					
OTHERS	Dimensions	111×35×20mm(L×W×H)				
	Packing	122×36×22mm(L×W×H)				
	Weight[G.W.]	77.5g±10g				



## LED Current Selection

Model	DIP Switch								
	<b>SE-9-350-700-G1T</b>	Output Current	350mA	400mA	450mA	500mA	550mA	600mA	
	Output Voltage	2-12V	2-12V	2-12V	2-12V	2-12V	2-12V	2-12V	ON OFF
	Output Power	0.7-4.2W	0.8-4.8W	0.9-5.4W	1-6W	1.1-6.6W	1.2-7.2W	1.3-7.8W	ON OFF
<b>SE-12-350-700-G1T</b>	Output Current	350mA	400mA	450mA	500mA	550mA	600mA	700mA	ON OFF
	Output Voltage	9-24V	9-24V	9-24V	9-24V	9-21.5V	9-20V	9-18.5V	ON OFF
	Output Power	3.15-8.4W	3.6-9.6W	4.05-10.8W	4.5-12W	4.95-11.8W	5.4-12W	5.85-11.7W	ON OFF
<b>SE-12-100-400-G1T</b>	Output Current	100mA	150mA	200mA	250mA	300mA	350mA	400mA	ON OFF
	Output Voltage	9-42V	9-42V	9-42V	9-42V	9-40V	9-34V	9-30V	ON OFF
	Output Power	0.9-4.2W	1.35-6.3W	1.8-8.4W	2.25-10.5W	2.7-12W	3.15-11.9W	3.6-12W	ON OFF
<b>SE-15-150-500-G1T</b>	Output Current	150mA	200mA	250mA	300mA	350mA	400mA	500mA	ON OFF
	Output Voltage	9-42V	9-42V	9-42V	9-42V	9-42V	9-37.5V	9-33V	ON OFF
	Output Power	1.35-6.3W	1.8-8.4W	2.25-10.5W	2.7-12.6W	3.15-14.7W	3.6-15W	4.05-14.85W	ON OFF
<b>SE-15-350-700-G1T</b>	Output Current	350mA	400mA	450mA	500mA	550mA	600mA	700mA	ON OFF
	Output Voltage	9-42V	9-37.5V	9-33V	9-30V	9-27V	9-25V	9-23V	ON OFF
	Output Power	3.15-14.7W	3.6-15W	4.05-14.85W	4.5-15W	4.95-14.85W	5.4-15W	5.85-14.95W	ON OFF

- \* After DIP switches set the current, power off and then power on to make the new current effective.
- \* E.g. LED 3V/pcs: 9-42V can power 3-14pcs LEDs in series, 9-21.5V can power 3-7pcs LEDs, the max quantity of LEDs in series will be subject to the actual voltage of LED.

## Product Size

Unit : mm

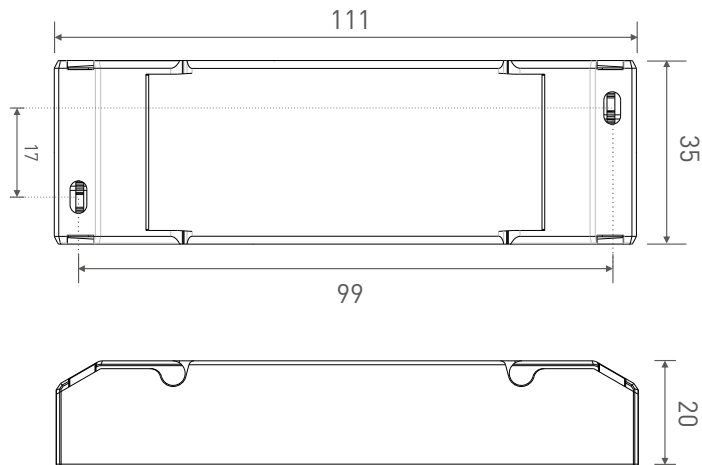

## Wiring Diagram

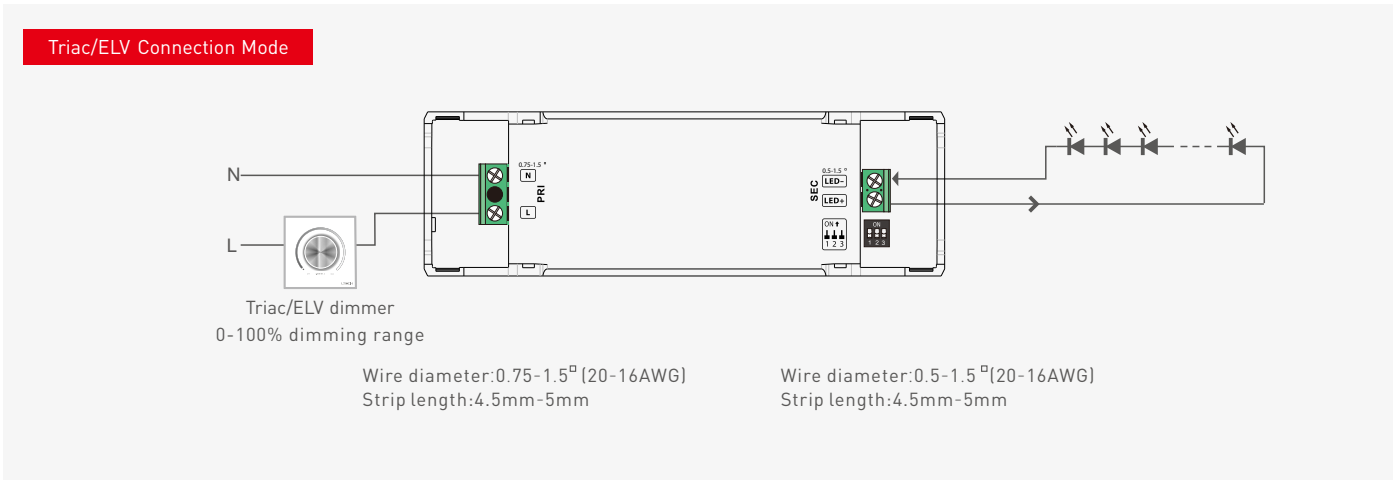

## Protective Housing Drawings



1. Pry up the protective housing in the side plate position with a tool.

2. Pry up the side edge of the tension plate with a tool to remove it.

3. Use a screwdriver to connect electrical wires as wiring diagram shows.

4. Press down the tension plate to fix the electrical wires.

5. Close the protective housing.

## Relationship Diagrams

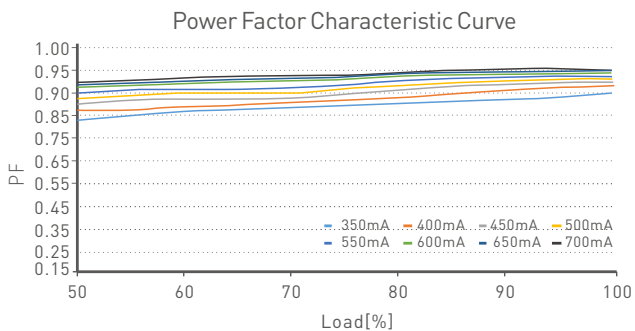
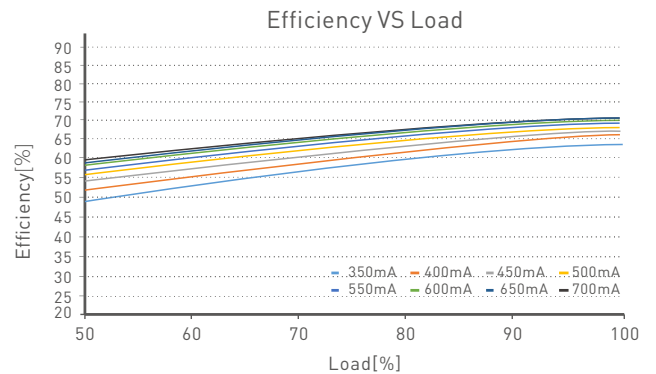
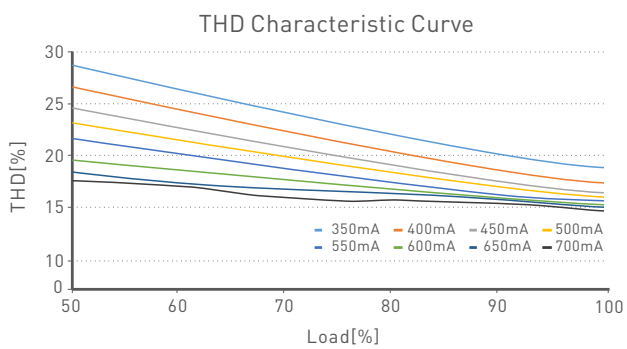

SE-9-350-700-G1T

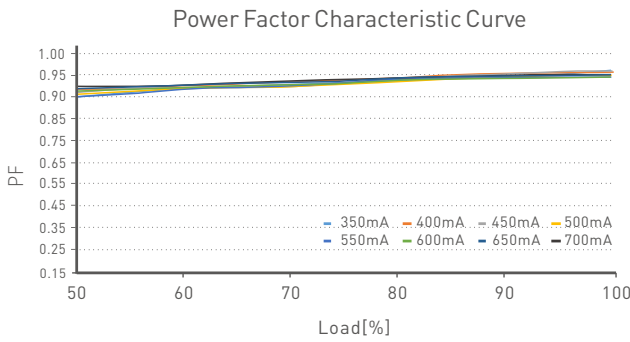
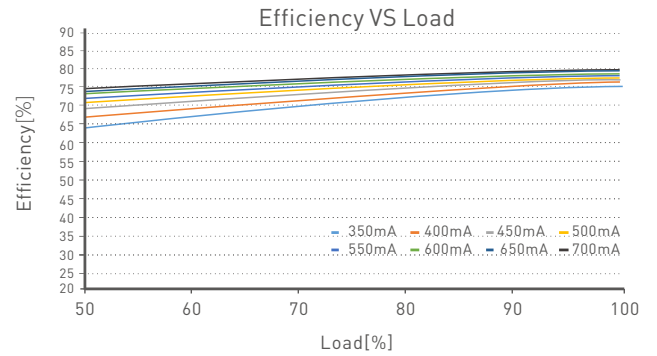
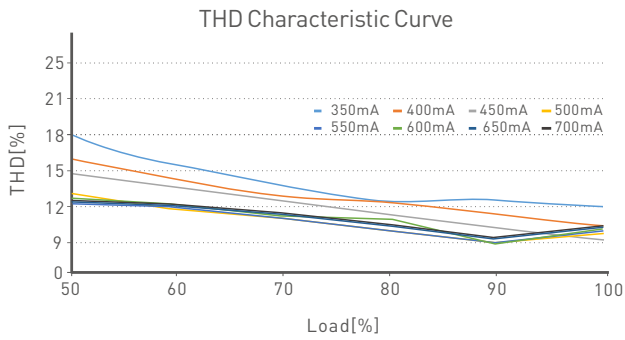

SE-12-350-700-G1T

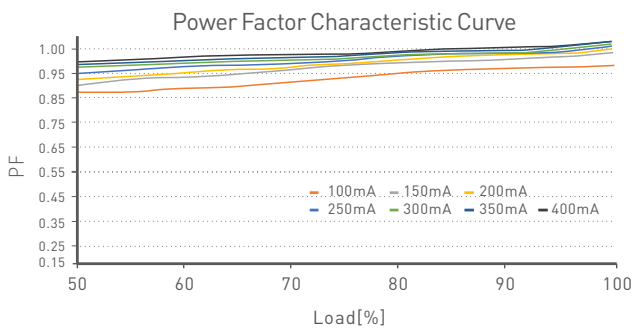
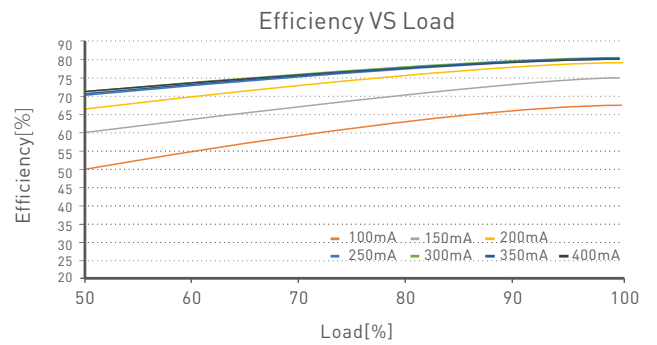
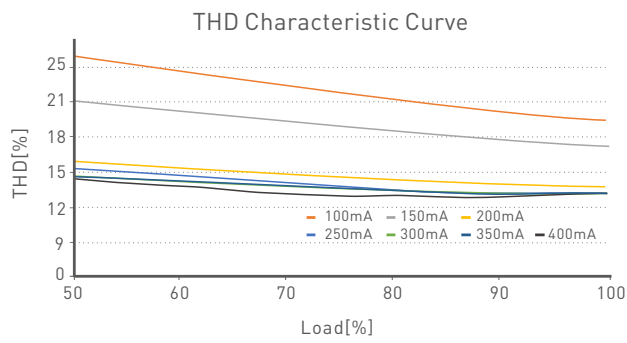

SE-12-100-400-G1T

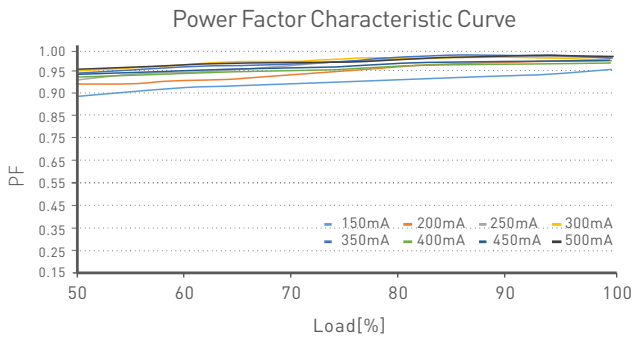
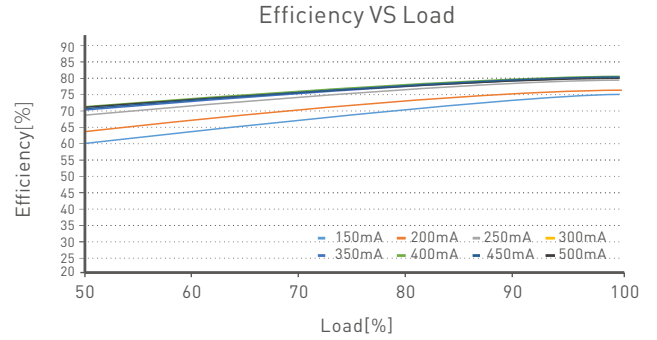
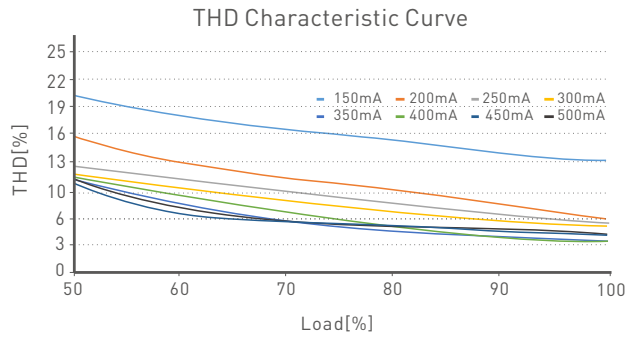

SE-15-150-500-G1T

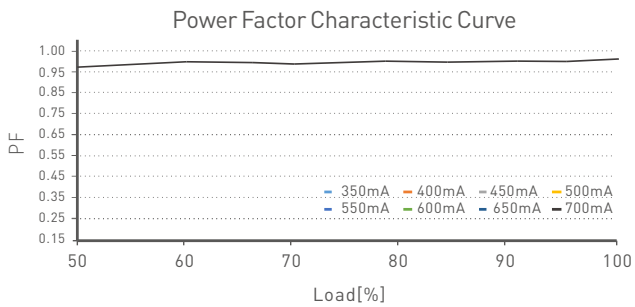
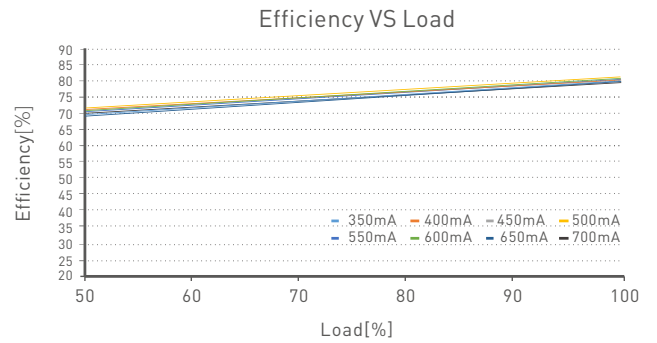
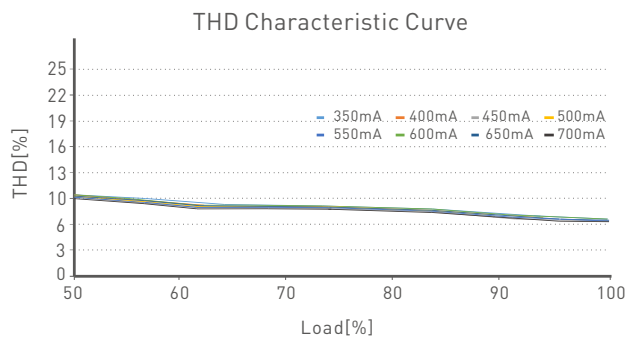

SE-15-350-700-G1T

## Flicker Test Table

IEEE 1789

Limit Value of Modulation in Low Risk Areas	
Waveform frequency of Optical output	Limit value (%)
$f \leq 8\text{Hz}$	0.2
$8\text{Hz} < f \leq 90\text{Hz}$	$0.025 \times f$
$90\text{Hz} < f \leq 1250\text{Hz}$	$0.08 \times f$
$f > 1250\text{Hz}$	Exemption assessment
Limit Value of Modulation in No Effect Areas	
Waveform frequency of Optical output	Limit value (%)
$f \leq 10\text{Hz}$	0.1
$10\text{Hz} < f \leq 90\text{Hz}$	$0.01 \times f$
$90\text{Hz} < f \leq 3125\text{Hz}$	$(0.08/2.5) \times f$
$f > 3125\text{Hz}$	Exemption assessment (High frequency exemption)

- Brightness
- ▲ 0.1%
  - ◆ 1%
  - ◆ 5%
  - ◆ 10%
  - 20%
  - 30%
  - 40%
  - ★ 50%
  - ★ 60%
  - ★ 70%
  - ★ 80%
  - ★ 90%
  - ◆ 100%

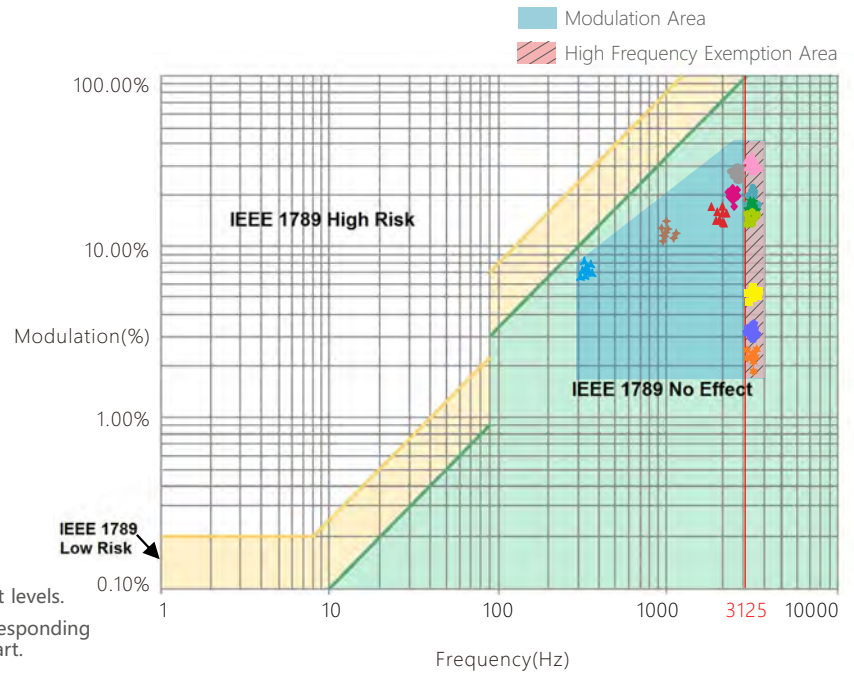

Marks in the right chart are tested results of different current levels. The output frequency is 0Hz in 100% brightness and its corresponding modulation is 0%, which could not be shown in the right chart.

### Attentions

- Products shall be installed by qualified professionals.
- LTECH products are non-waterproof (special models excepted). Please avoid the sun and rain. When installed outdoors, please ensure it is mounted in a water proof enclosure.
- Good heat dissipation will extend the working life of products. Please ensure good ventilation.
- Please check if the working voltage used complies with the parameter requirements of products.
- The diameter of wire used must be able to load the light fixtures you connect and ensure the firm wiring.
- Before you power on products, please make sure all the wiring is correct in case of incorrect connection that causes damage to light fixtures.
- If a fault occurs, please do not attempt to fix products by yourself. If you have any question, please contact your suppliers.

\* This manual is subject to changes without further notice. Product functions depend on the goods. Please feel free to contact our official distributors if you have any question.

### Warranty Agreement

- Warranty periods from the date of delivery : 5 years.
- Free repair or replacement services for quality problems are provided within warranty periods.

#### Warranty exclusions below:

- Beyond warranty periods.
- Any artificial damage caused by high voltage, overload, or improper operations.
- Products with severe physical damage.
- Damage caused by natural disasters and force majeure.
- Warranty labels and barcodes have been damaged.
- No any contract signed by LTECH.

1. Repair or replacement provided is the only remedy for customers. LTECH is not liable for any incidental or consequential damage unless it is within the law.
2. LTECH has the right to amend or adjust the terms of this warranty, and release in written form shall prevail.

### Update Log

Version	Updated Time	Update Content	Updated by
A0	2020.02.21	Original version	Xu Shujun
A1	2021.04.01	Added technical specifications, LED current level selection and relationship diagrams for other four models of this product. Updated the protective housing drawings.	Xu Shujun